



SMART VENT[®]

WET FLOODPROOFING PRODUCT CATALOG



SALES AND TECHNICAL SUPPORT

**HAVE A QUESTION?
WE CAN HELP!**

Our full staff of Certified Floodplain Managers is on call to answer any questions you may have.

CALL A LIVE REPRESENTATIVE
toll free (877) 441-8368

EMAIL
directly to:
info@smartvent.com

LIVE CHAT
with a member of our team online at www.smartvent.com



NEED TO ORDER?
Locate one of our Authorized Dealers
smartvent.com/locator

STAY CONNECTED!

CONNECT WITH YOUR LOCAL REPRESENTATIVE
have a local representative come out to your location, www.smartvent.com/contact

FIND US ON SOCIAL MEDIA



[/SmartVentNJ](https://www.facebook.com/SmartVentNJ)



[@SmartVentNJ](https://twitter.com/SmartVentNJ)



[/SmartVent](https://www.youtube.com/SmartVent)



[Smart Vent Products Inc](https://www.linkedin.com/company/Smart-Vent-Products-Inc)

20 YEARS OF ENGINEERED FLOOD PROTECTION

First Smart Vent installation in Avalon, NJ. 1999



Smart Vent Products, Inc. was born out of the need to create flood vents -- a safeguard mandated by the Federal Emergency Management Agency, the National Flood Insurance Program, and State and National Construction Codes. Beginning in 1986, flood vents were required for use in all enclosed spaces located below Base Flood Elevation. Along with this new requirement came the challenge of moving beyond the very limited solutions available to create one that was both effective and affordable. Previously, the only solutions available for relief of hydrostatic pressure were air vents, which would clog with debris during a flood event.

Determined to provide just that, a draftsman in Avalon, NJ set to work. The answer laid in finding a way to relieve hydrostatic pressure with a product that would work automatically, be bi-directional by allowing for the entry and exit of flood water and allow for debris to easily pass through without clogging a screen or grill. Further research showed that the design must also be rodent resistant and be constructed with a proven, flood-proof material.

Using 316L Marine Grade Stainless Steel, Smart Vent Products, Inc. provided the first-ever line of Engineered Flood Vents. In addition, the company developed the performance testing standards relied upon today -- providing owners of homes and buildings located in the floodplain the peace of mind of knowing that their foundations are protected.

After two decades of ICC-ES performance testing, countless floods and hurricanes, and recognition from state, national and federal agencies and organizations, Smart Vent products are proven. Our team of outstanding and highly trained engineers remains committed to excellence in all we do.

Our work continues as Smart Vent's team of Certified Floodplain Managers and Engineers introduce a new division, The Flood Risk Evaluator™. Its focus is on providing our customers with solutions for reducing the ever-rising flood insurance premiums.

We are proud to be owned and operated in the United States of America, with all manufacturing done in Anderson, SC. From our humble beginnings in Avalon, NJ to our worldwide success today, Smart Vent remains true to our principles of providing the best floodplain-protection products and services available industry wide.

See pages #22-23 for details on how the Flood Risk Evaluator® is helping everyone involved in the building process, including the homeowner.

Extreme MAKEOVER HOME EDITION

Smart Vent helping rebuild in New Orleans, following Hurricane Katrina. Circa 2009



Habitat for Humanity

Smart Vent taking part in Kitatas County Ellensburg, WA Habitat for Humanity project. Circa 2009



Smart Vent as seen in "This Old House Jersey Shore Rebuilds". 2013

This Old House
JERSEY SHORE REBUILDS



ICC-ES CERTIFIED

Certification # ESR-2074



The Smart Vent line of products has been Certified through the International Code Council Evaluation Service (ICC-ES), which is the building industry's most recognized certification process. The ICC-ES is a nonprofit company that performs technical evaluations on building products, components, methods and materials. A certification from the ICC-ES ensures the construction official, inspector, architect, engineer, and surveyor that the product meets the construction code requirements. A Certification through the ICC-ES is also a FEMA and NFIP requirement for manufactured, engineered flood vents.

To obtain Certification, we first needed to pass the established Acceptance Criteria for performance testing flood vents. Testing requires us to push our vents to the limits; a real life simulated flood situation had to be created which included various rates of flow and a specific amount of flood debris in the water. The Acceptance Criteria not only made performance testing mandatory but it also required that we meet material and quality assurance standards as established by the ICC-ES.

Our facility in Anderson, SC is ISO 9001 certified which allows us to exceed all ICC-ES quality control standards. On an annual basis, our manufacturing facility is audited by the ICC-ES, to inspect the production of our Smart Vent product line, which ensures the ICC-ES requirements are continuously being met.

In addition to our National ICC-ES Certification we are proud to say our product line also carries Florida Building Product Approval (FL5822) for use in High Velocity Hurricane Zones (HVHZ), and has also met evaluation standards for California building and residential codes (see ICC-ES Florida and California Supplements).

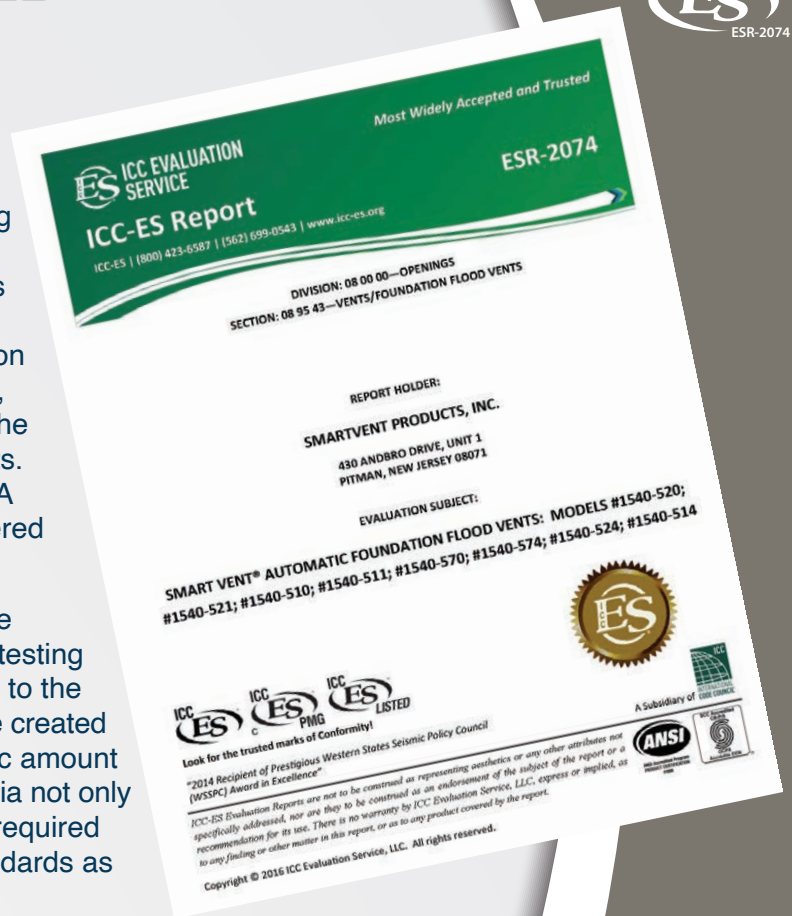

FLOOD RESISTANT MATERIALS

The Smart Vent product line is constructed out of Marine Grade Stainless Steel and is 100% made in the United States. T316L Stainless Steel is renowned for its ability to withstand usage in harsh marine and chemical environments, ensuring that our products will handle everything Mother Nature throws at them.

Because T316L Stainless Steel is known for its strength and resistance to cracking, dents, and embrittlement, it's utilized in high profile projects meant to last decades. Alloyed with Chrome, Nickel, and Molybdenum, T316L Stainless Steel takes the strength of steel and adds protection, making it the ultimate flood resistant material.



WHAT? HOW? WHY?



WHAT IS A FLOOD VENT?

Smart Vent's line of ICC-ES Certified, Engineered Flood Vents protect houses and buildings during floods by preventing hydrostatic pressure buildup that can destroy walls and foundations. This mitigation technique, referred to as Wet Floodproofing, allows floodwater to freely flow through an enclosure such as a crawlspace or garage.



HOW DOES IT WORK?

The SMART VENT door is latched closed until flood water is present. Rising flood water activates the internal floats, which unlatch and open the door. Smart Vent's 3-inch clearance, when open, helps let flood debris pass through unlike a typical air vent that will clog.

Pictured to the left: Debris easily getting through a 1540-510 model during Hurricane Ida, 2009.

Pictured to the right: Positioning of one of the internal floats.

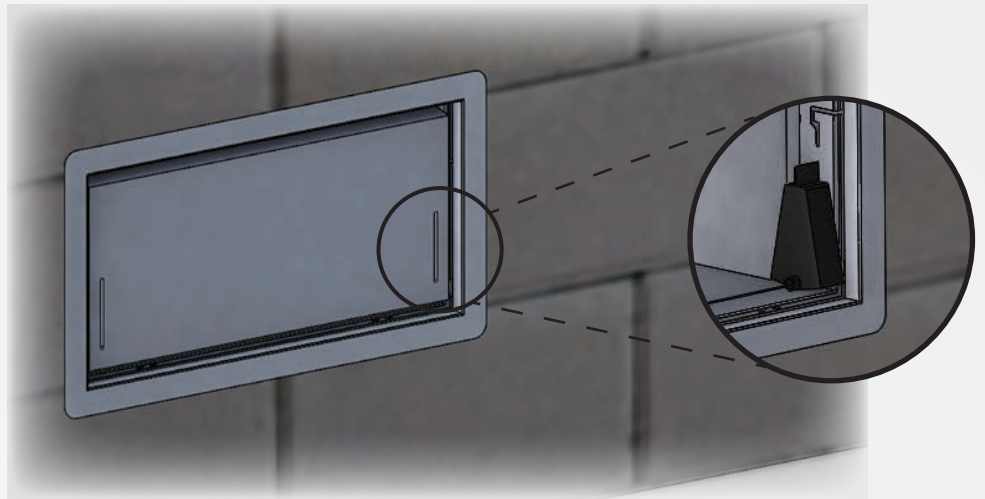

WHY DO I NEED IT?

FEMA and NFIP Regulations along with Building Codes require that any residential building constructed in Flood Zone Type A have the lowest floor, including basements, elevated to or above the Base Flood Elevation (BFE).

Enclosed areas are permitted under elevated buildings provided that they meet certain use restrictions and construction requirements such as the installation of flood vents to allow for the automatic entry and exit of flood waters.

This wet floodproofing technique is required for residential buildings, and is also an option for commercial buildings.

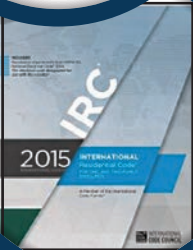

PLACEMENT REQUIREMENTS

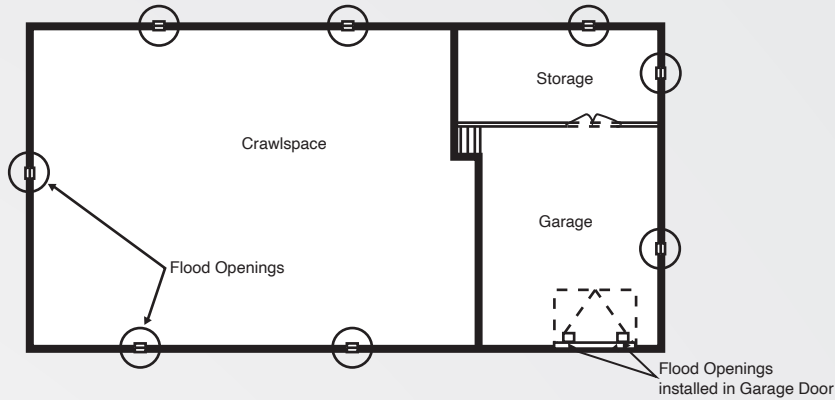

- Each enclosed area is required to have a minimum of 2 openings on exterior walls to allow floodwaters to enter and exit directly. (FEMA TB-1, PAGE 13)
- The openings should be installed on at least 2 sides of each enclosed area below the Base Flood Elevation. (FEMA TB-1, PAGE 13)
- The bottom of each flood vent is to be located no higher than 1 foot above the highest interior or exterior adjacent grade below the vent opening. (FEMA TB-1, PAGE 14)

Examples of where flood vents can be utilized:

- 1 Crawlspace**
- 2 Attached Garages**
- 3 Walkout Enclosures**
- 4 Detached Buildings**
- 5 Houses with Enclosures Elevated on Pilings**
- 6 Commercial Buildings**
(See pgs 20-21 for examples)



STANDARD FINISH POWDER COAT WHITE
POWDER COAT PAINT OPTIONS:



Custom colors also available.



MODEL NUMBER	FLOOD COVERAGE	AIR VENTILATION	VENT SIZE	ROUGH OPENING
1540-510	200 sq. ft.	51 sq. in.	16" W x 8" H x 3" D	16 $\frac{1}{4}$ in x 8 $\frac{1}{4}$ in
1540-511	400 sq. ft.	102 sq. in.	16" W x 16" H x 3" D	16 $\frac{1}{4}$ in x 16 $\frac{3}{8}$ in



To view other sizing options see pages #18-19

DUAL FUNCTION SERIES

This series of vents offers certified flood venting protection with superior automatic natural ventilation control. Ideal for crawlspace applications and other areas requiring flood venting protection as well as natural air ventilation.

VENTILATION

A bimetal coil automatically opens and closes the ventilation louvers as temperature changes from 35° F to 75° F.

No electricity is required.

In the event of a flood, the internal floats lift to release the flood door to rotate open and relieve the hydrostatic pressure regardless of the louvers' position, open or closed.

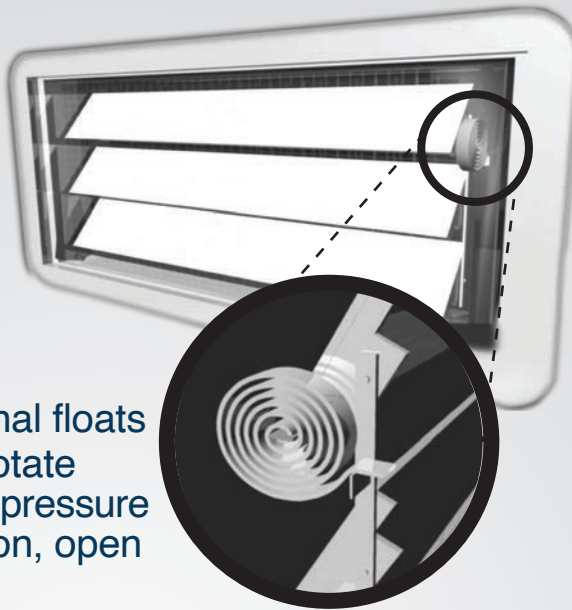

1 Smart Vent 1540-510

2 Stacker 1540-511

Stacker Models are twice as efficient as a single unit and are a great solution for large amounts of square footage, and in situations where there is not enough wall space to fit in the necessary or required single units.



1 Pictured in custom powder coat black



2 Pictured in powder coat white

STANDARD FINISH POWDER COAT WHITE
POWDER COAT PAINT OPTIONS:



Custom colors also available.



1



MODEL NUMBER	FLOOD COVERAGE	VENT SIZE	ROUGH OPENING
1540-520	200 sq. ft.	16"W x 8"H x 3"D	16 $\frac{1}{4}$ in x 8 $\frac{1}{4}$ in
1540-521	400 sq. ft.	16"W x 16"H x 3"D	16 $\frac{1}{4}$ in x 16 $\frac{3}{8}$ in
1540-570	200 sq. ft.	14 $\frac{1}{2}$ "W x 8 $\frac{1}{2}$ "H x 3"D	14 $\frac{1}{2}$ in x 8 $\frac{3}{4}$ in



To view other sizing options see pages #18-19

INSULATED SERIES

This series of vents is ideal for areas requiring flood venting protection but no natural air ventilation.

The flood door contains a 2" Styrofoam core that has an R-value of 8.34 and the vent frame is lined with felt weather stripping, helping to keep the enclosure as insulated from the elements as possible.

IDEAL FOR:

- Garages
- Full height enclosures (e.g. walkouts)
- Conditioned crawlspaces
- Storage facilities
- Metal buildings
- Foyers

1 Flood Vent 1540-520

2 Stacker 1540-521

Stacker Models are twice as efficient as a single unit and are a great solution for large amounts of square footage, and in situations where there is not enough wall space to fit in single units.

3 Wood Wall 1540-570

Wood Wall Models are designed to fit between studs spaced at 16" on center. Pre-drilled slots in the four corners on the vent flange make for an easy installation.

See page 13 for the Sealing Kit, available for 1540-520 & 1540-521 Models.

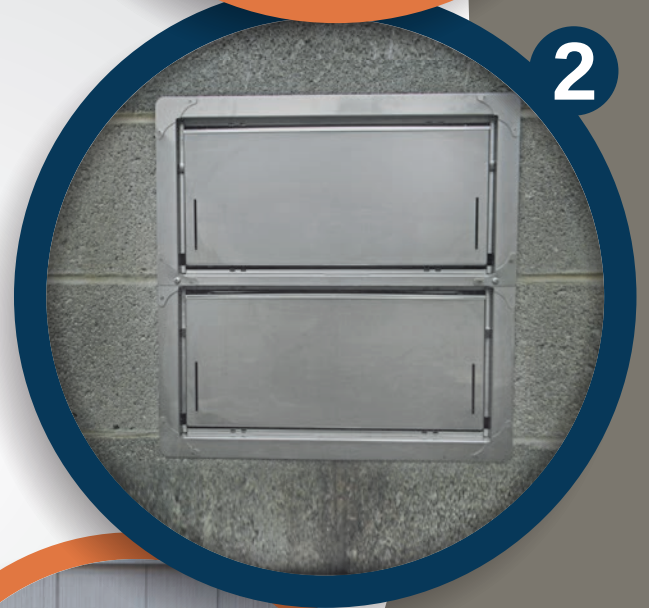

Pictured in powder coat paint gray



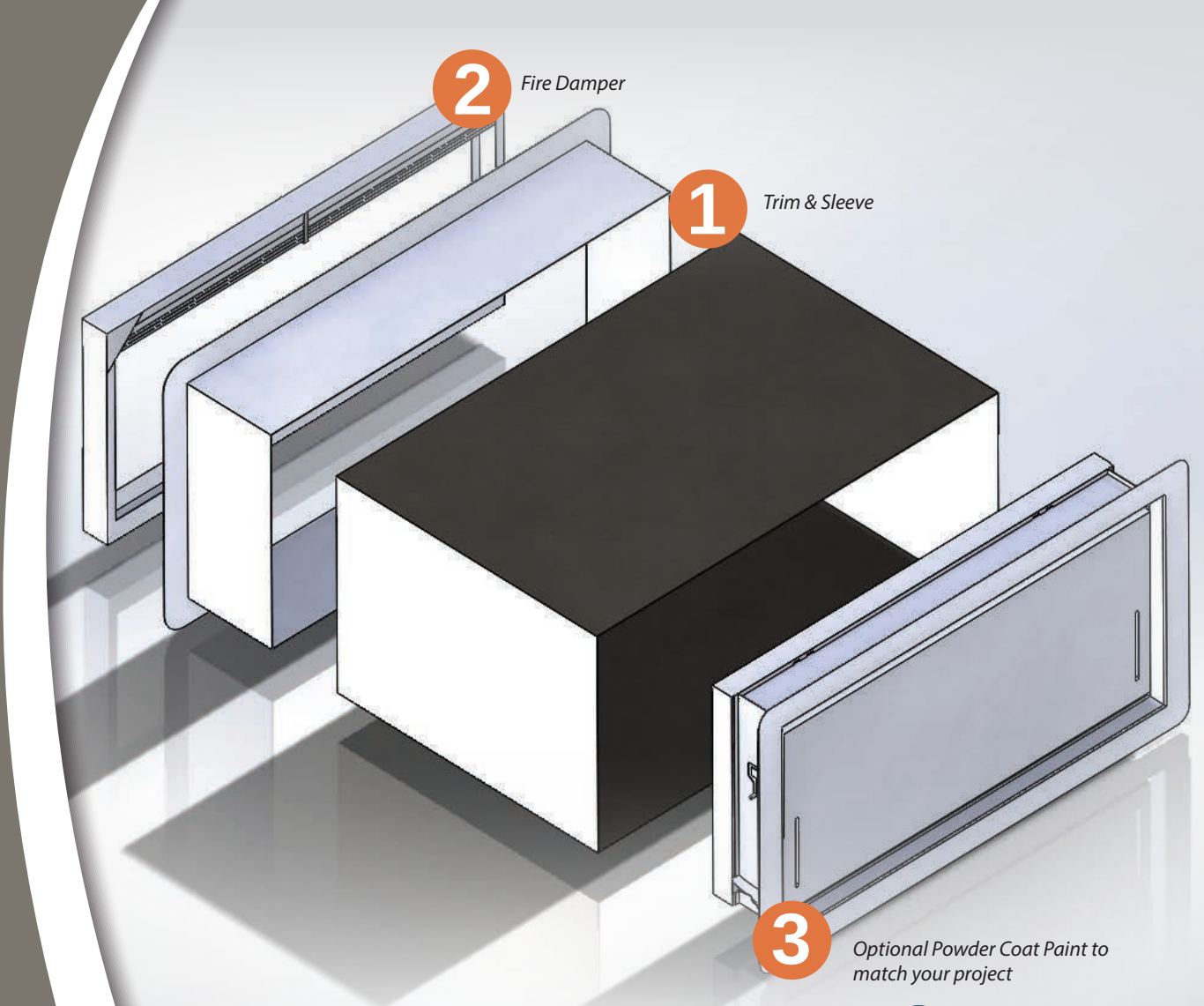

ACCESSORIES & PAINT OPTIONS

Smart Vent Products, Inc. offers everything you need to complete your project.

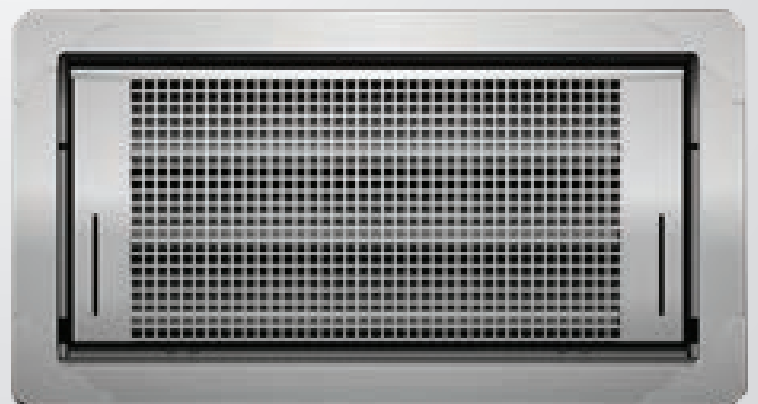
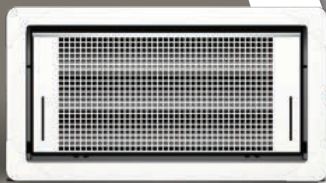

1 Trim & Sleeve Kits

Trim and sleeve kits fit into the rough opening in order to provide a clean, finished look on the interior wall.

They are available for all compatible models including multi-frame units.* *not available for Overhead Garage Door models



STANDARD MODELS

FOR 16" x 8" VENTS (2 PIECE)

- 1540-531-12
kits adjustable from 7" - 12.5"
- 1540-531-15
kits adjustable from 10" - 15.5"

Standard finish:
316L Stainless Steel

WOOD WALL MODELS

FOR 14.5" x 8.5" VENTS (1 PIECE)

- 1540-573
4" wall depth
- 1540-573-9
9" wall depth

Standard finish:
Powder Coat White

2 Fire Dampers

Our two Fire Damper models are UL Certified to provide 2 or 3hrs of fire resistance. They are intended to be used when flood vents are being installed into a fire rated wall. Available for models up to a 2 x 3 configuration.

A fusible link holds a galvanized steel door in place. At 165° F, the link melts to permit the door to drop, blocking the path of the fire.

NOTE: Trim flange and inner sleeve are required for installation, as well as an 8" minimum wall thickness.



STANDARD 16" x 8" MODEL

- 1540-530
2 or 3 hour fire resistance available

STANDARD 14.5" x 8.5" MODEL

- 1540-537
2 or 3 hour fire resistance available

3 Powder Coat Paint

Smart Vent Products, Inc. offers all of their flood vents in Stainless Steel, Standard Powder Coat Paint Colors of: White, Wheat, Gray, or Black, but can be custom color matched to your project's needs.

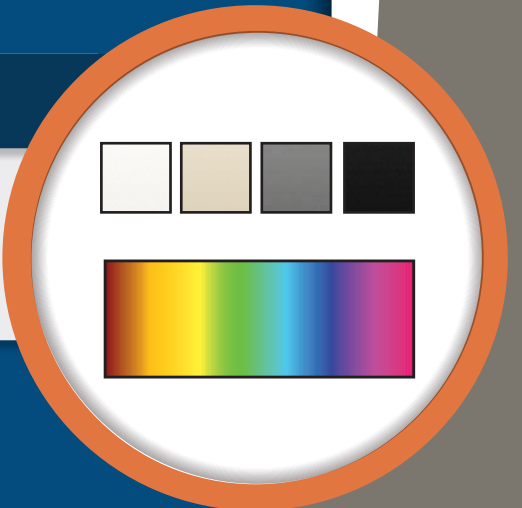

NEW

**ENERGY
EFFICIENT
UPGRADE**



FLOOD VENT SEALING KIT

This simple, energy efficient upgrade is for any new or existing SMART VENT Insulated Model #1540-520 in your home or business.

Model #
1540-526

The **NEW Flood Vent Sealing Kit (Model #1540-526)** works to create a **tight seal** behind the vent opening and finish off the interior space while the vent is not in use. When a flood event occurs, the pre-cut Homasote® material blows out from the area in the center, creating a now unobstructed opening to allow the insulated flood door to open automatically. Because the **Homasote® is composed of 98% recycled material**, it is biodegradable and will decompose leading to less post-flood cleanup.



Key Features ★

- Easy to Retrofit onto 1540-520 Smart Vent Flood Vent Models
- **Meets 2018 Energy Codes**
- ICC-ES Certified and LEED Compliant
- ICC-ES Certified Homasote® insert
- Creates Tight Seal Equivalent to a Window
- Mold and Mildew Resistant
- Comes in Clean White Finish
- Requires minimum 7 in. Wall Depth

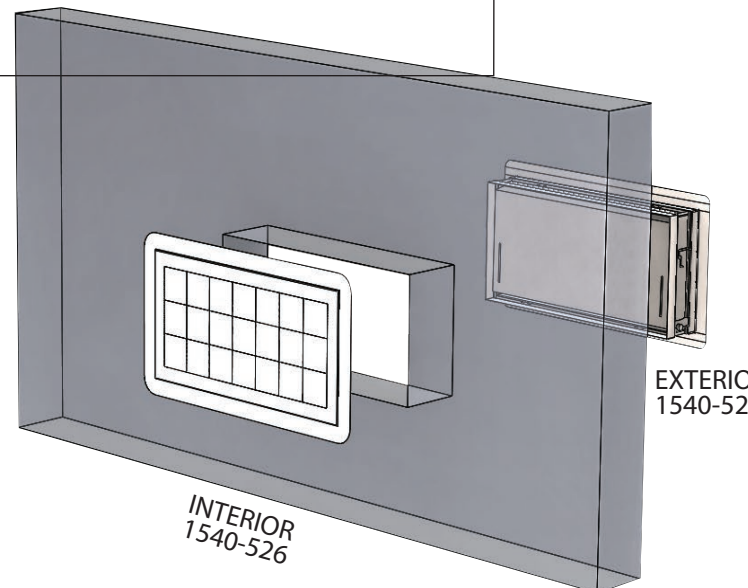

CALL (877) 441-8368 FOR ORDERING DETAILS!

HURRIBOND™

FORMULATED FOR THE TOUGHEST APPLICATIONS

2IN1 ADHESIVE & CAULK

HurriBond™ is a fast curing, multi-purpose, modified silicone sealant and adhesive. When fully cured, this unique VOC compliant formula offers UV stability and tenacious stress-free adhesion to many common substrates. We specifically formulated this product to offer superior all-weather performance. **HURRIBOND™ IS SPECIFIED FOR THE INSTALLATION OF SMART VENTS.**



FAST CURING



INTERIOR/EXTERIOR



PAINTABLE



SANDABLE

PRODUCT ADVANTAGES:

- High Strength Adhesion
- Adhesion to Kynar®
- Non-Corrosive
- Alternative to Mechanical Fastening
- Contains no Solvents or Isocyanates
- VOC Compliant
- Odorless
- Non-Yellowing or Staining
- Resistant to Most Chemicals
- Will not Shrink or Crack
- Color Stability and UV Resistant (ASTM G26)



"Guns easy and smooth, love that it's for interior and exterior. ...paintable and sandable. We use it for just about anything around the house." - **BRADLEY, HurriBond™ User**
McKeelwork, Inc. | Dunn, NC

MODEL NUMBER	COLOR	COVERAGE	SIZE (ozs)
HB-3100	White	1 tube installs 6 vents	10.3oz
HB-3200	Gray	1 tube installs 6 vents	10.3oz

AVAILABLE COLORS:

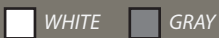

www.hurribond.com
for more information and videos



GARAGE DOOR MODELS

The Overhead Garage Door Models are specifically designed for standard garage doors and other entry doors that open and close on a daily basis. They are an ideal retrofit, and are available in insulated style and dual function when situations call for natural air ventilation through the garage.



MODEL NUMBER	FLOOD COVERAGE	AIR VENTILATION	VENT SIZE	ROUGH OPENING
1540-524	200 sq. ft.	NONE	16"W x 8"H x 3"D	16 in x 8 in
1540-574	200 sq. ft.	NONE	14 $\frac{1}{2}$ " W x 8 $\frac{1}{2}$ " H x 3"D	14 $\frac{1}{2}$ in x 8 $\frac{3}{4}$ in
1540-514	200 sq. ft.	51 sq. in.	16"W x 8"H x 3"D	16 in x 8 in

Standard finish: Powder Coat White

Powder Coat Paint Options: White, Wheat, Gray & Black

Custom colors also available.

POUR-IN-PLACE VINYL BUCKS

The Pour-in-Place Vinyl Bucks are utilized in poured concrete walls. They are manufactured out of high-strength white PVC. Bucks come fully assembled with the vent model of your choice and include wood bracing for installation into forms along with a film that protects the vent during the pour.

Pour-in-Place Vinyl Bucks are easy to install, saving time on installation and present a nice, clean, finished look.

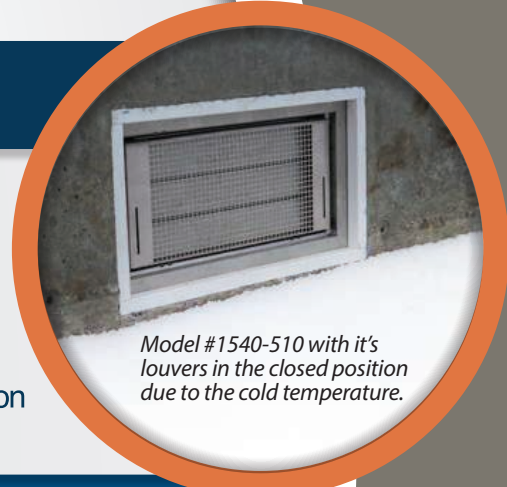

Model #1540-510 with its louvers in the closed position due to the cold temperature.

AVAILABLE FOR:

- Wall depths ranging from 5.5" to 12" including nominal and full sizes
- Pour-in-Place Bucks have the capability to accept the following models:

DUAL FUNCTION SERIES

- 1540-510
- 1540-511

INSULATED SERIES

- 1540-520
- 1540-521

MULTI-FRAMES

- 2 x 1
- 2 x 2
- 2 x 3
- 3 x 1
- 3 x 2



Pour-in-Place Vinyl Bucks are available in white only.

Flood vent inserts come standard in Marine Grade 316 Stainless Steel, with full-spectrum custom color powder coat options available.

*Pictured to the right:
Insulated Series in
2 x 3 multi-frame
configuration*



MODEL NUMBER	CONFIGURATION	FLOOD COVERAGE	AVAILABLE IN "E" *
1540-150102	1W x 2H	400 sq. ft.	X
1540-150103	1W x 3H	600 sq. ft.	X
1540-150201	2W x 1H	400 sq. ft.	X
1540-150202	2W x 2H	800 sq. ft.	X
1540-150203	2W x 3H	1200 sq. ft.	X
1540-150301	3W x 1H	600 sq. ft.	X
1540-150302	3W x 2H	1200 sq. ft.	X
1540-150303	3W x 3H	1800 sq. ft.	
1540-150401	4W x 1H	800 sq. ft.	
1540-150402	4W x 2H	1600 sq. ft.	
1540-150403	4W x 3H	2400 sq. ft.	
1540-150501	5W x 1H	1000 sq. ft.	
1540-150502	5W x 2H	2000 sq. ft.	
1540-150503	5W x 3H	3000 sq. ft.	
1540-150601	6W x 1H	1200 sq. ft.	
1540-150602	6W x 2H	2400 sq. ft.	
1540-150603	6W x 3H	3600 sq. ft.	

CHOOSE A FLOOD DOOR STYLE:

MODEL NUMBER	DOOR STYLE
1540-0239	Insulated
1540-0039	Dual Function

To start the multi-frame design process, please contact our technical support team at **(877) 441-8368** or email plans@smartvent.com.

MULTI-FRAMES

Multi-frames are ideal for commercial applications and other areas with large square footages; they give you the flood venting protection you need with fewer openings. They accommodate our dual function or insulated series of flood doors, and are manufactured in a robust one-piece design.

MULTI-FRAME CONFIGURATIONS

SMART VENT has a team of engineers and Certified Floodplain Managers on hand to help you with your next commercial project. We offer full CAD capabilities that allow you to implement the multi-frame design easily into your project drawings. We will assist in proper vent placement and help with all phases of the project to assure the flood vent system is installed correctly and meets your specifications.

FRAME OPTIONS:

STANDARD MULTI-FRAMES

- Made of $\frac{1}{8}$ " thick angle iron for an extremely sturdy, and element resistant design.
- Powder coat painted, just choose color:

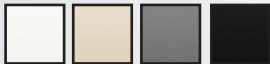

Custom colors also available.

“E” MULTI-FRAMES

- Constructed with the same superior design using a lighter steel material to provide a more economical solution for some projects.
- Standard finish is 316L Stainless Steel



Dual Function Series in 2 x 2 multi-frame configuration, powder coated black



Insulated Series in 2 x 2 multi-frame configuration, installed in a metal building, powder coated wheat

Smart Vent multi-frame units installed at the Medical University of South Carolina.



MULTI - FRAME PROJECT SAMPLES

Smart Vent's team of engineers and Certified Floodplain Managers work side-by-side with architects to construct various stable and aesthetically pleasing building designs where flood venting is a necessity.

STANDARD FINISH 316L STAINLESS STEEL
POWDER COAT PAINT OPTIONS:

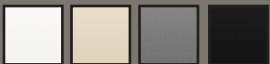

Custom colors also available.

1. New York, NY - Corona Maintenance Facility

- (33) 5 x 3 multi-frame configurations



2. Beaverton, OR - Porche Dealership

- (4) 2 x 1 multi-frame configurations
- (27) 2 x 2 multi-frame configurations
- Powder coated black units



3. Danville, PA - Middle School Retrofit

- (48) 3 x 2 multi-frame configurations
- (25) 3 x 3 multi-frame configurations
- (3) 2 x 3 multi-frame configurations



4. Washington State - Green House

- (13) 1 x 6 multi-frame configurations



5. Ferndale, WA - Silver Reef Casino

- (37) 2 x 3 multi-frame configurations
- Powder coated custom brown units

To start the multi-frame design process, please contact our technical support team at (877) 441-8368 or email plans@smartvent.com.

TO BEGIN YOUR REVIEW,
SEND PLANS TO:
PLANS@SMARTVENT.COM
OR UPLOAD YOUR FILES AT:
<https://www.hightail.com/u/smartvent>

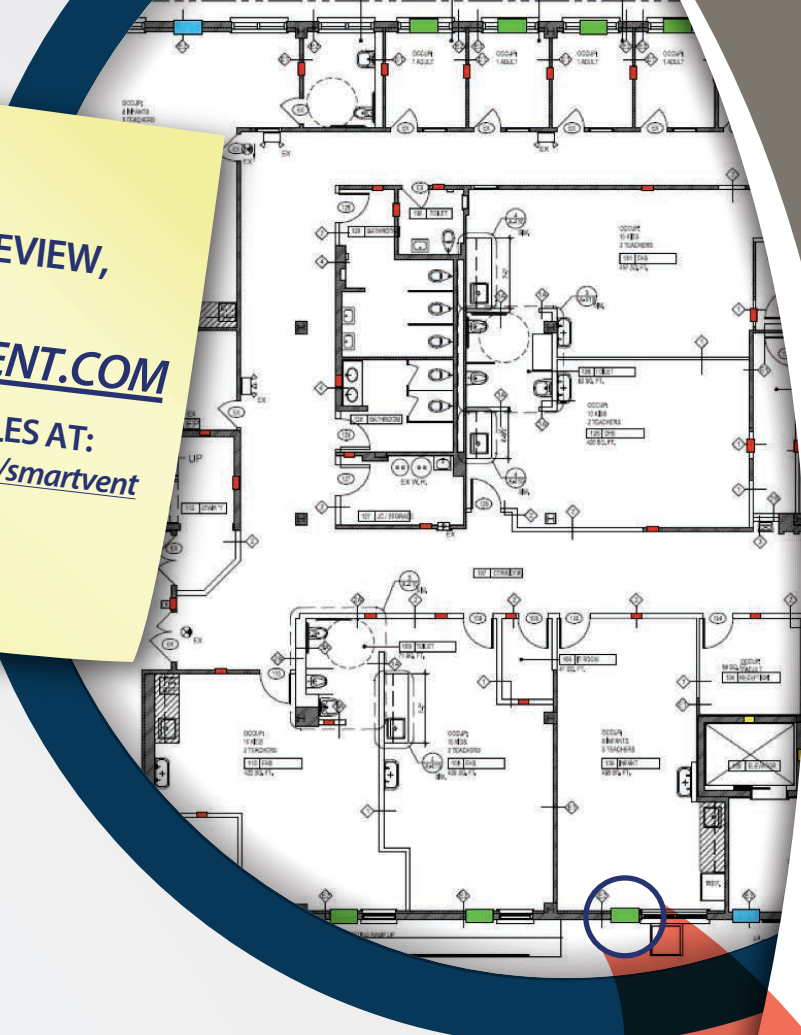

FLOOD PLANS DIVISION

DESIGNING IN THE FLOODPLAIN DOESN'T HAVE TO BE DIFFICULT...

COMPLIMENTARY FLOOD PLAN REVIEW

- Team of Certified Floodplain Managers will customize a Floodproofing solution to your residential or non-residential floodplain projects.
- We make sure your project is compliant with all FEMA and NFIP regulations, with ICC building codes, and is receiving the lowest possible flood insurance premium.
- Our team of floodplain engineers will provide you with a product schedule and detailed floodproofing layout.
- Schedule a Lunch & Learn or webinar (1 HSW), and have your plans reviewed by our team prior to your session.

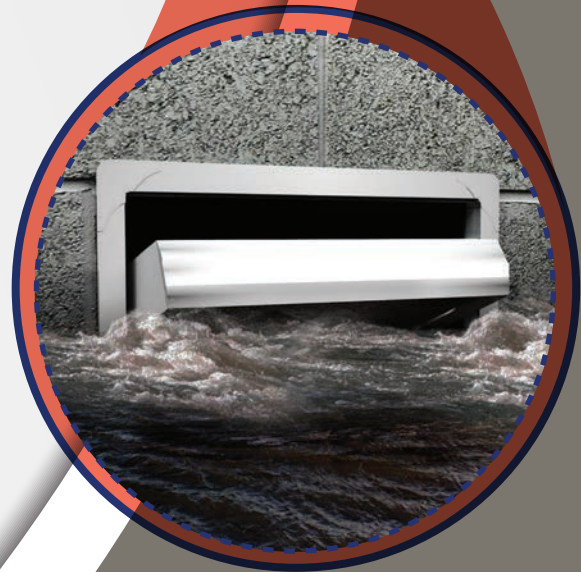

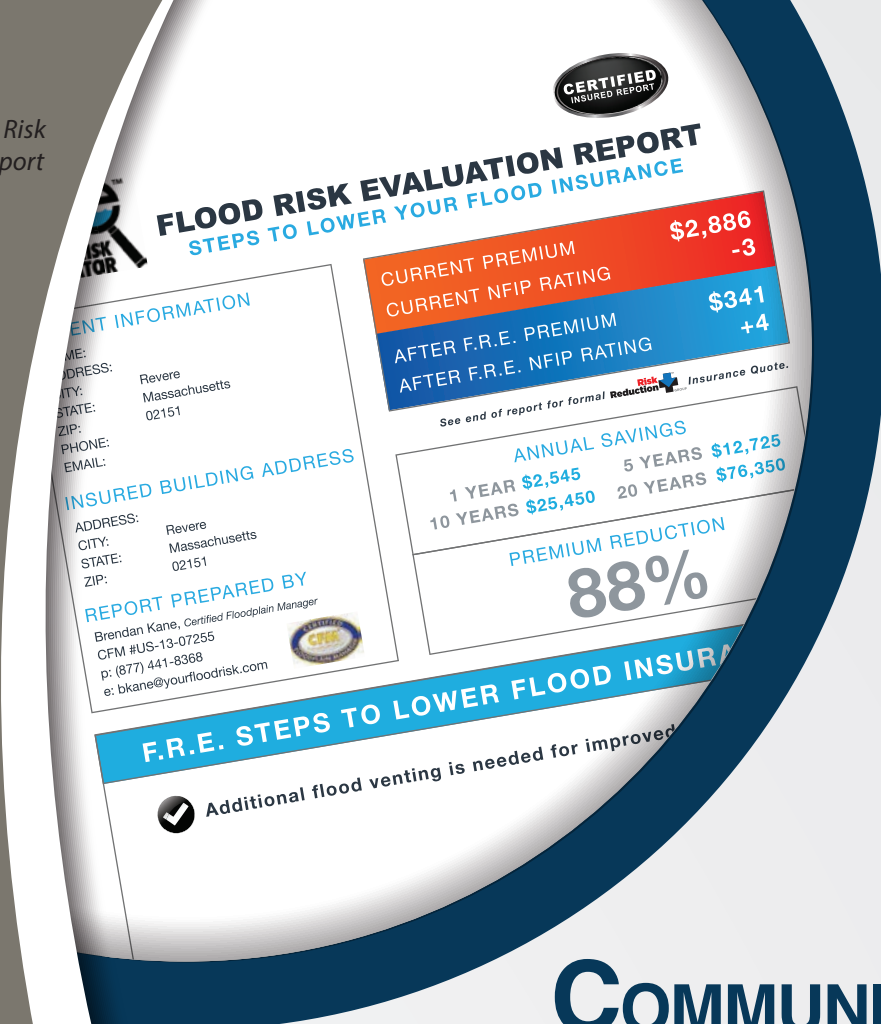

COMMUNITY SUPPORT

Our staff of Certified Floodplain Managers and Engineers are proficient with National Flood Insurance Program changes that affect Flood Insurance Policies and make it their top priority to help property owners reduce their premiums.

Community Outreach Seminars are available.

- Residents can take advantage of on-the-spot mitigation guidance
- Communities who host events are eligible to earn CRS Section 330 points

To learn how to host an outreach event or to find out where to attend, contact us at info@yourfloodrisk.com



Through the use of our **Flood Risk Evaluator™** service, we can provide:



NFIP POLICY REVIEW

Analysis of your flood insurance policy to expose errors that may be causing you unnecessary expense.



AVAILABLE MITIGATION STEPS

Ways to modify conditions in your home or building to reduce flood insurance costs.



FLOOD INSURANCE QUOTES

A complete F.R.E. Flood Risk Evaluation Report with a no obligation flood insurance quote based on our recommendations.



To view more information on these services, or to upload your documents, visit www.yourfloodrisk.com.

To find out what you can save, send copies of your current policy declaration page and elevation certificate to ec@yourfloodrisk.com.

“Through F.R.E., our annual premium went from \$3,200 down to \$511! That’s a 84% reduction! We even received a refund check from our Insurance Agent for the difference in premium since we paid up-front for the year. We’re thankful for F.R.E.’s mitigation recommendations as just a few months later we got flooded and the Smart Vents that we installed performed flawlessly and saved our home from collapsing.” - **ROB & JOHANNA WAGNER**
Homeowners | Peoria, IL

View our video online at smartvent.com/media.





Register your vents online: smartvent.com/register



430 Andbro Drive, Unit 1 • Pitman, NJ 08071
(p) 877-441-8368 • (w) www.smartvent.com • (e) info@smartvent.com